

Nova M3 MON300 Monitor Card Specifications

V2.0.1 2013-11-12

1. Functions

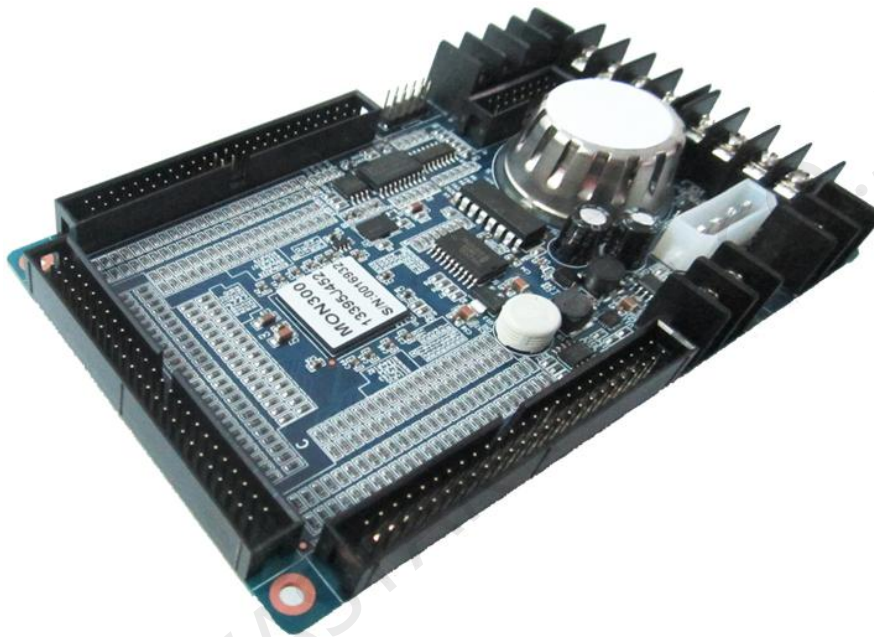

Nova M3 MON300 is a monitor card designed specifically for engineering projects and projects with high requirements of safety. It has the following characteristics:

- 1) Used together with receiving card MRV320;
- 2) Support LED open and short circuit detection (drive IC support required);
- 3) Support flat cable fault detection;
- 4) Support cabinet humidity detection (no extra purchase necessary);

- 5) Support cabinet temperature detection (no extra purchase necessary);
- 6) Support 8-way power supply voltage detection;
- 7) Support 4-way fan speed detection;
- 8) Cabinet door open/close status detection supported;
- 9) Monitor card HUB required for LED status inspection or flat cable detection;

2. Dimensions and definition

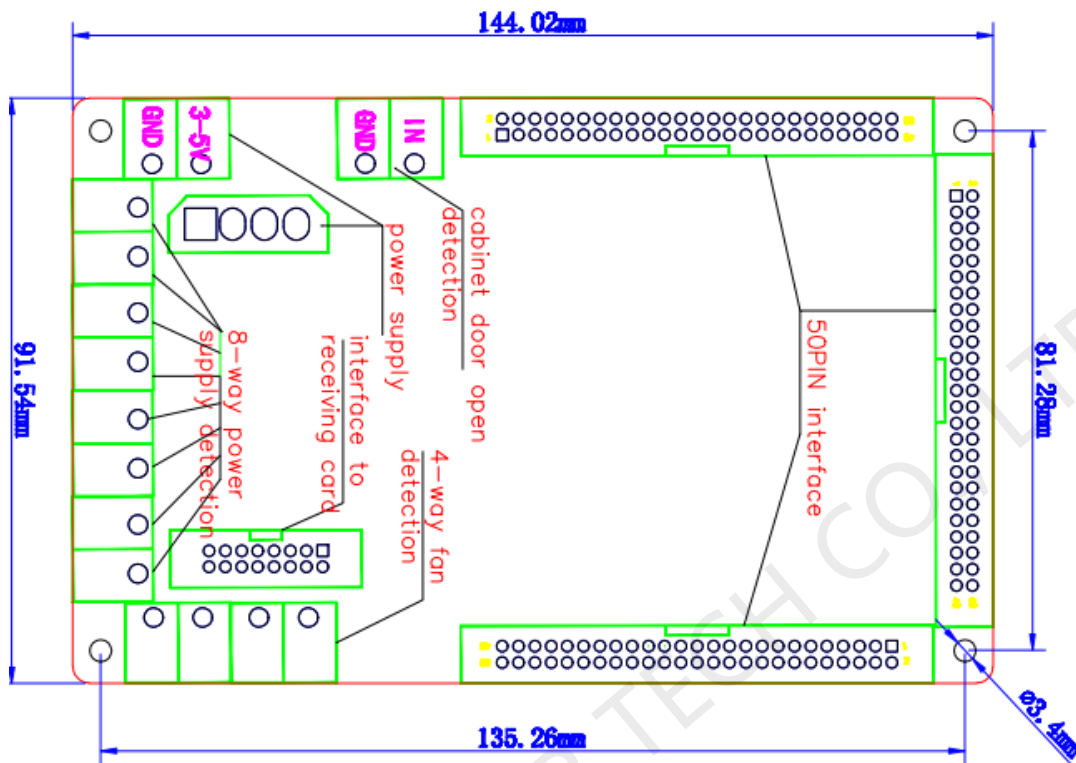

Fig. 2-1 MON300 Dimensions

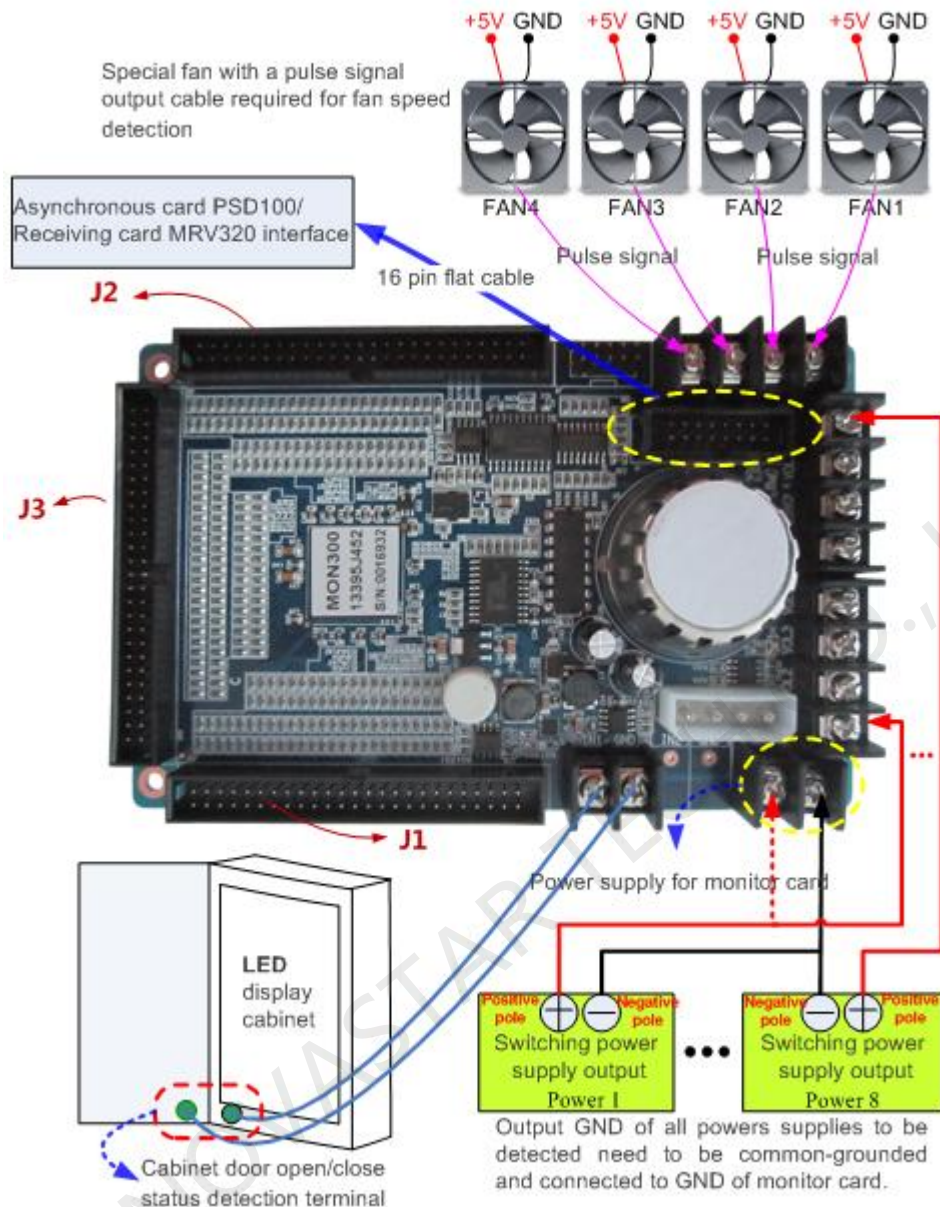
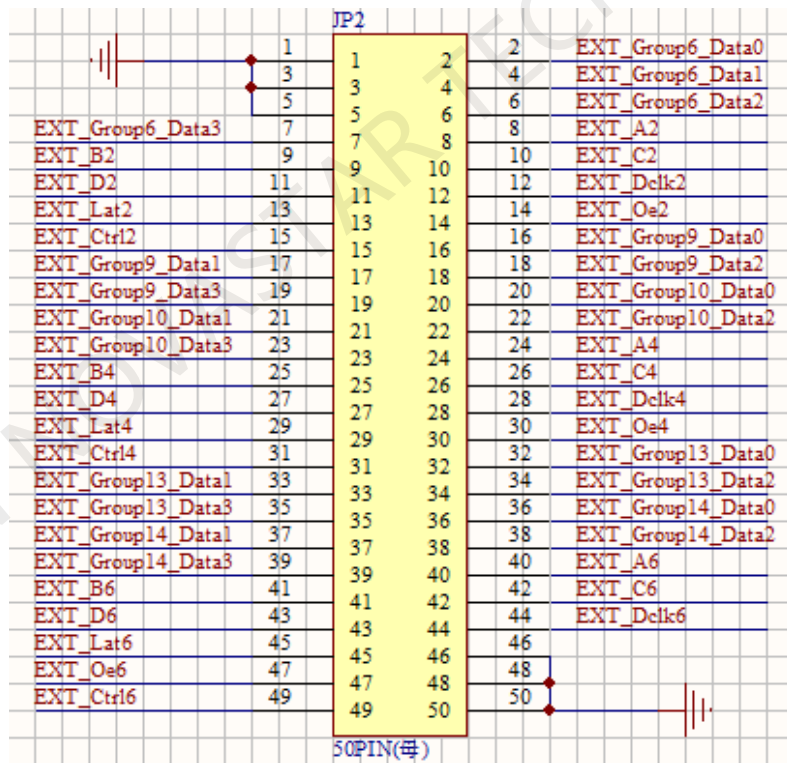
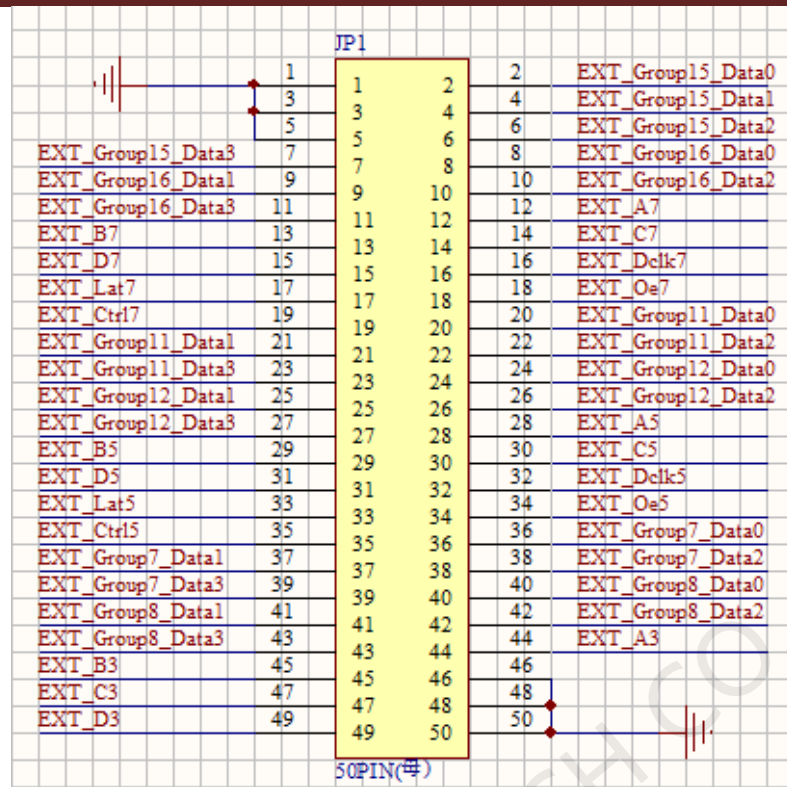
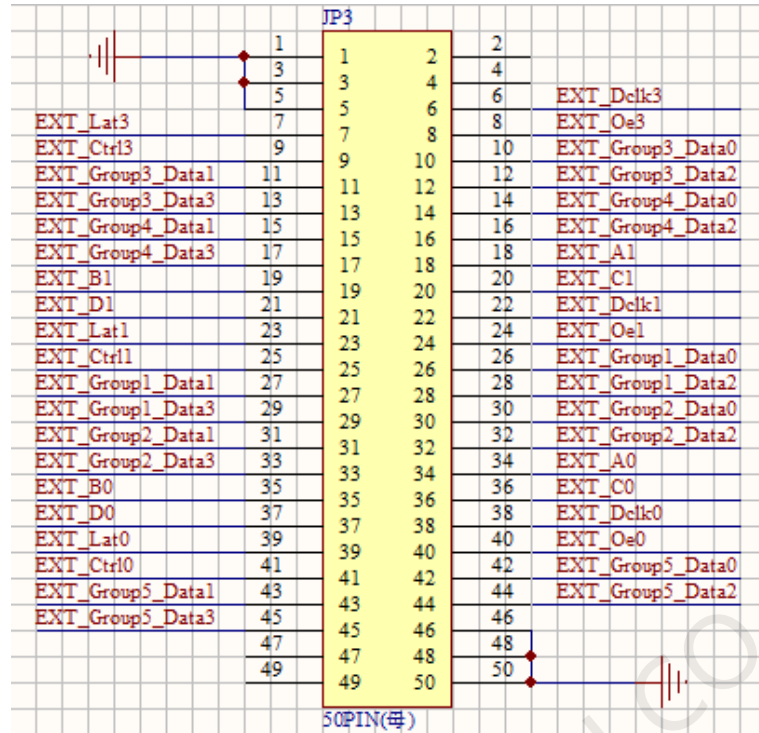

Fig. 2-2 MON300 Interface diagram

3. Interface definition (Please design HUB according to below definition)

1) 16-group data mode





2) 20-group data mode

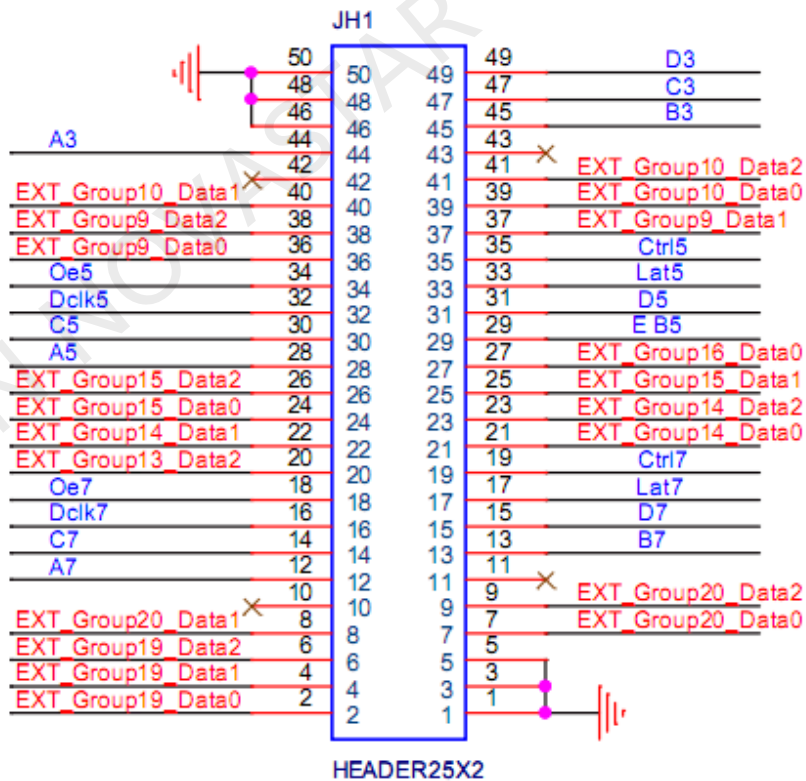

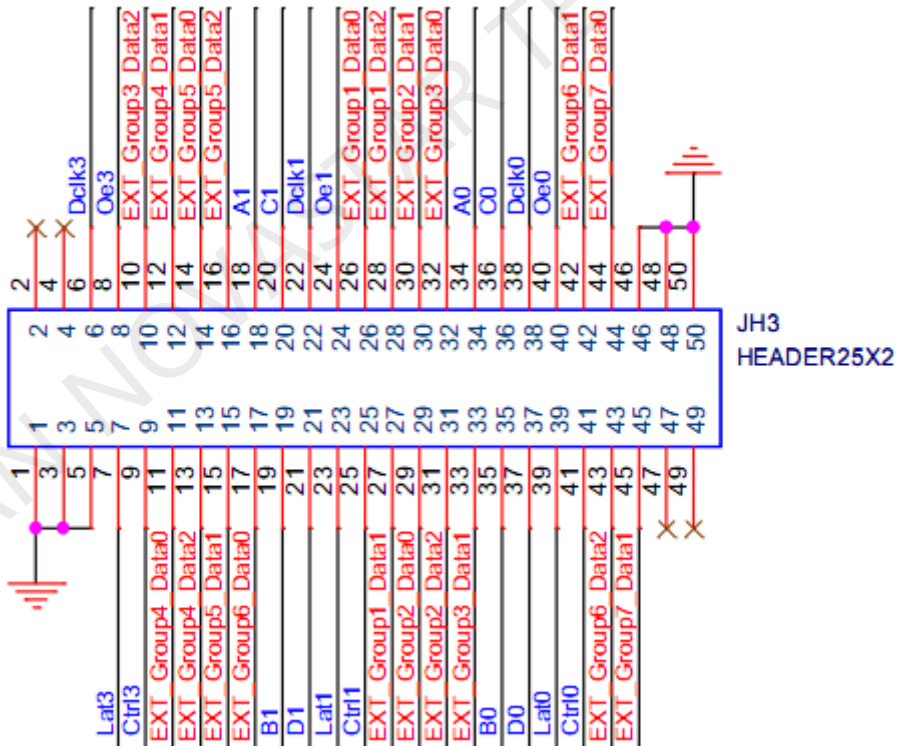
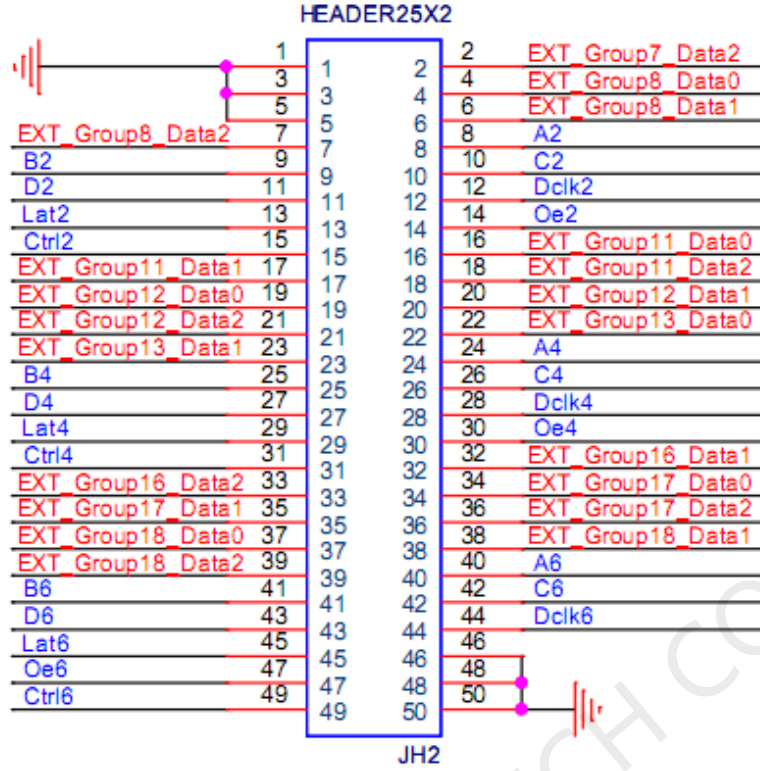

4. Connection

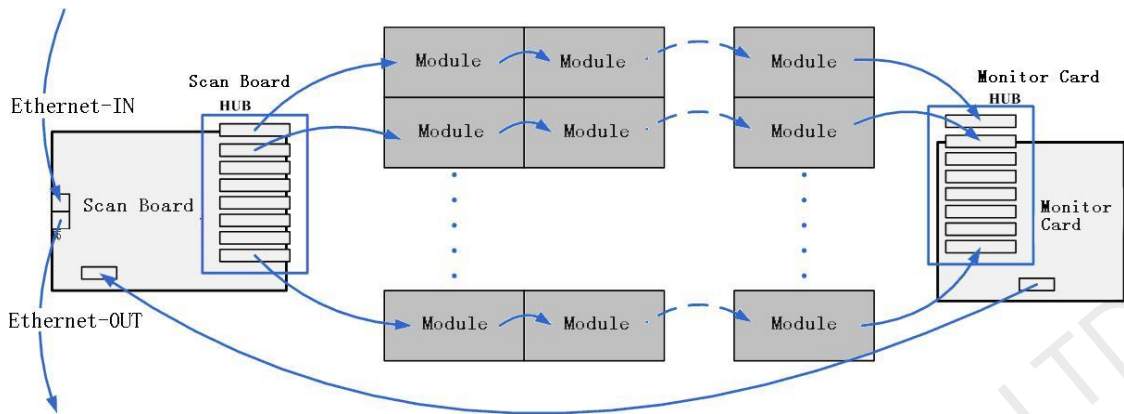

Fig. 4-1 Connection diagram

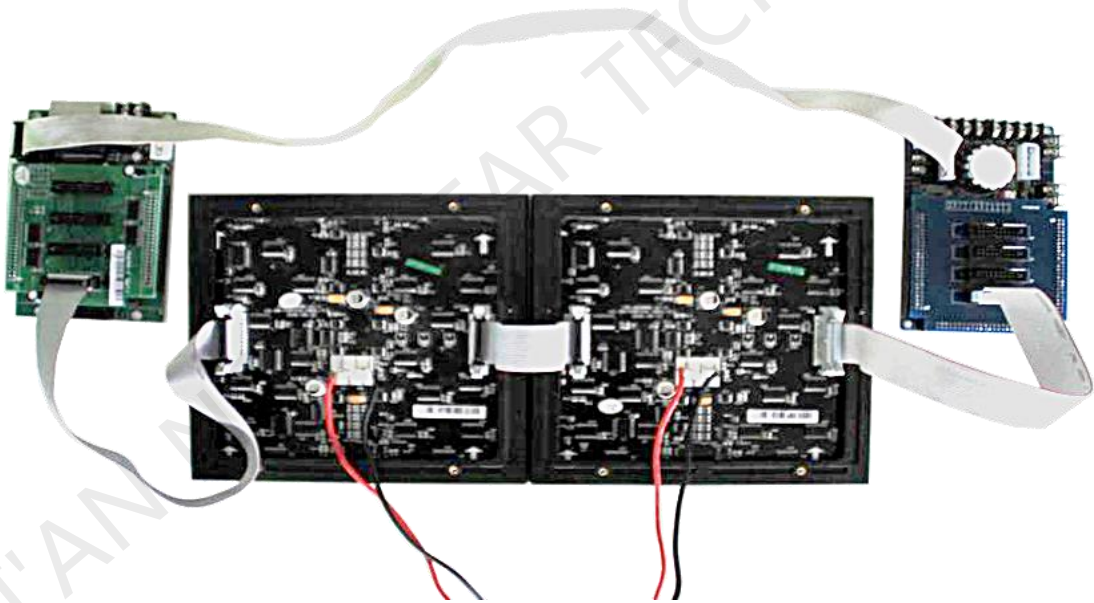

Fig. 4-2 Physical connection

5. Working conditions

Rated voltage (V)	5	Maximum	5.5	Minimum	3.3
Rated current (A)	0.15	Maximum	0.2	Minimum	0.12
Rated power consumption (W)	0.65	Maximum	0.7	Minimum	0.55
Working environment temperature (°C)	-20°C~75°C				
Working environment humidity (%)	0%~95%				
Working environment range of smoke sensor	Environment temperature	-20°C~60°C		Notice: When operating temperature of the system card is higher than 60°C, while the relative humidity is higher than 60%, smoke sensor warning may happen. See Figure 5-1.	
	Environment humidity	0%~60%			
Performance testing parameters					
Humidity (%)	Maximum		99	Minimum 1	
Smoke	FW HW < 0.7Mev				

Voltage	Maximum	12	Minimum	0
---------	---------	----	---------	---

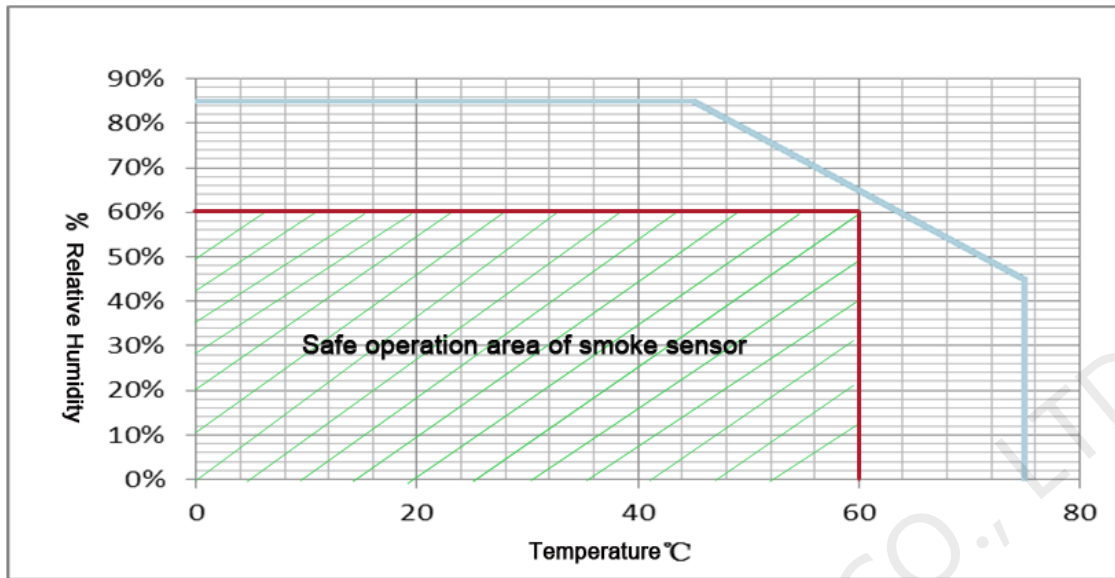

Fig. 5-1 Safe operation area of smoke sensor